

80A / 100A

▶ DOOR INTERLOCK MOUNTING - LONG METAL SHAFT EXTENSION



Technical Info (p.192)

PADLOCKABLE PRESENTATION

Yellow/Red Handle
Part Number

Grey Handle
Part Number

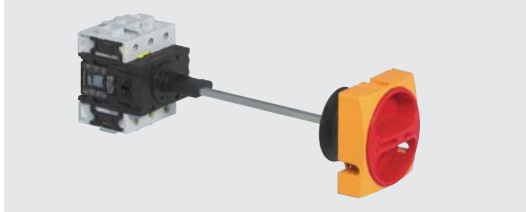

0165409LS

80 A

3P
3P + NC/NO
4P neutral on left
4P + NC/NO

0165409LS
0165419LS
0165429LS
0165439LS

0168409LS
0168419LS
0168429LS
0168439LS

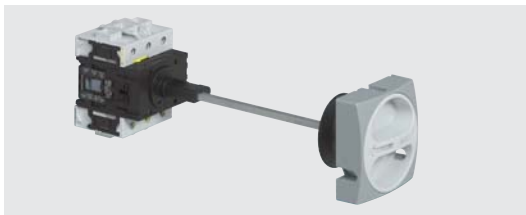

0168509LS

100 A

3P
3P + NC/NO
4P neutral on left
4P + NC/NO

0165509LS
0165519LS
0165529LS
0165539LS

0168509LS
0168519LS
0168529LS
0168539LS

STANDARD VERSIONS IP40 RATED.

TO ORDER WITH IP65 GASKETS ADD -1 TO PART NUMBERS ABOVE.
IE. 0165409LS-1

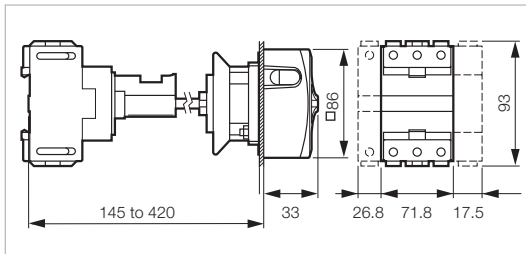

COMPONENTS AND ACCESSORIES

Part Number



0172400

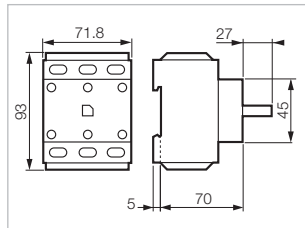

3-pole switch body without handle

80 A
100 A

0172400
0172500

Additional pole

80 A
100 A

0172475
0172575

Neutral pole

80 A
100 A

0172465
0172565

Junction block

Ground or Neutral

0172585

Auxiliary contact
NC/NO

0172179

IP65 Seal Kit

0174269

Replacement Handle

86 - Yellow/Red
 86 - Grey

0172621
0174621



0172475

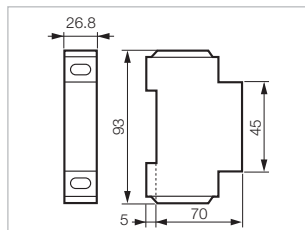

Technical Specifications

▶ GENERAL

Characteristics	25 A	32 A	50 A	63 A	80 A	100 A
UL/cUL - suitable as motor disconnect						
> Rated voltage (V)	600	600	600	600	600	600
> General Use Current (A)	25	32	50	63	80	100
> Motor Ratings (hp)						
1 x 120 V	0.75	1	1.5	3	3	5
1 x 240 V	1.5	2	3	5	10	10
1 x 277 V	2	3	5	7.5	10	15
3 x 120 V	1.5	2	3	5	7.5	10
3 x 240 V	3	5	7.5	10	20	25
3 x 480 V	7.5	10	15	20	40	50
3 x 600 V	7.5	10	15	20	40	50
> Auxiliary Blocks						
NO/NC	A600					
Early Make	B300					
Early Break	B300					
> Wire Gauge (AWG)						
3-Pole Body, Additional Pole, Late Break Neutral, Junction Block	8 - 14	8 - 14	4 - 14	4 - 14	1 - 14	1 - 14
Auxiliary Contacts	14 - 18	14 - 18	14 - 18	14 - 18	14 - 18	14 - 18
> Short Circuit Rating						
Fuse Type K5 (A)	5000	5000	5000	5000	5000	10000
Fuse Size (A)	40	40	80	80	125	125
Rated break capacity	330	330	800	800	800	800

Technical Specifications

► GENERAL

Characteristics	25 A	32 A	50 A	63 A	80 A	100 A
IEC						
> Rated insulation voltage U_i (V)	690	690	690	690	690	690
> Conventional free air thermal current I_{th} Uninterrupted rated current I_u (A)	25	32	50	63	80	100
> Conventional enclosed thermal current I_{the} (A)	20	25	40	50	63	80
> Rated impulse withstand voltage (overvoltage category III - pollution degree 3 U_{imp} (kV)	6	6	6	6	6	6
> Rated operating current I_e (A) AC - 21 A/22 A Conform to IEC 60947-3	25	32	50	63	80	100
> Rated operating power (kW)						
AC 23 A						
3 x 230 V	5.5	5.5	15	15	18.5	22
3 x 400 V	7.5	11	18.5	22	30	37
3 x 500 V	7.5	11	22	30	37	45
3 x 690 V	7.5	11	18.5	22	22	30
AC 3						
3 x 230 V	4	4	7.5	11	15	18.5
3 x 400 V	5.5	7.5	15	18.5	22	30
3 x 500 V	5.5	7.5	15	22	30	37
3 x 690 V	5.5	7.5	15	18.5	18.5	22
> Make - break characteristics ($A_{eff}/400$ V)						
Rated make capacity	710	710	1270	1270	1970	1970
Rated break capacity	330	330	800	800	800	800
> Short circuit characteristics						
Rated short term withstand current I_{cW} ($A_{eff}/400$ V/1 s)	350	430	500	760	1100	1500
Rated short circuit make capacity I_{cm} (kA peak/400 V)	1	1	1.8	1.8	2.8	2.8
Short circuit current (kA $_{eff}/400$ V)	10	10	10	10	10	10
with fuse gl/gG (A)	25	32	50	63	80	100

Technical Specifications

► ENCLOSURES

Characteristics	150x100x96	220x150x100	220x150x100	220x150x100	220x150x100	300x200x100
> Rating	25 and 32 A 3P to 4P +NC/NO	25 and 32 A 6P and 6P +NC/NO	50 and 63 A 3P to 4P +NC/NO	50 and 63 A 6P and 6P +NC/NO	80 and 100 A 3P and 3P +NC/NO	80 and 100 A 4P to 6P +NC/NO
> Cable inputs	2 x 2 PG 16 OR 2 x 2 M25	2 x 2 PG 21	2 x 2 PG 21	2 x 2 PG 29	2 x 2 PG 29	2 x 2 PG 21 2 x 2 PG 29
> Ø knockouts (mm)	PG 16: 22.5 ISO M25: 25	28.5	28.5	37.5	37.5	37.5 and 28.5
> No. of knockouts (top and bottom)	2	2	2	2	2	4
> Panel mount	by 2 screws	by 4 screws	by 4 screws	by 4 screws	by 4 screws	by 4 screws
> Base/cover assembly	by 1 screws self-tapping stainless steel	by 4 screws self-tapping stainless steel	by 4 screws self-tapping stainless steel	by 4 screws self-tapping stainless steel	by 4 screws self-tapping stainless steel	by 6 screws self-tapping stainless steel
> Switch/base assembly	on 35 mm DIN rail (this rail is notched for positioning the switch)					
> Handles mounting	screwing on shaft pre-pierced cover					
> Insulation	Class II installed (provided that the correct insulation plugs are used with the enclosure)					
> Impact withstand	IK07					
> Flameproof	650°C					
> Protection rating	IP 66	IP 40 (IP 65 upon request)				
> Contact operating diagram						
> Switch padlocking	In general: up to 3 padlocks ø 4 to 8 mm Switch with 1 auxiliary contact NC/NO: up to 3 padlocks ø 6 to 8 mm Modular presentation: 1 padlock ø 6 to 8 mm					

Technical Specifications

► MOUNTING - PANEL DRILLING

Panel/Door Handle Mounting

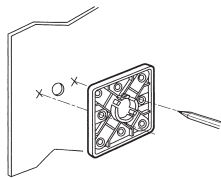
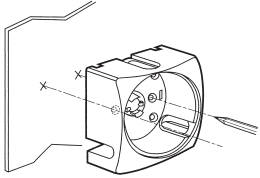

25A/32A

50A/63A/80A/100A

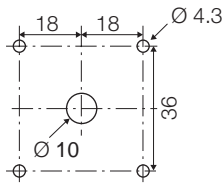
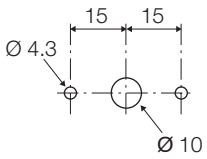

Ø22 Single Hole Mounting

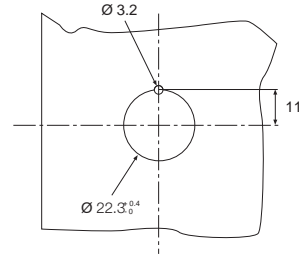

Door Interlock System

Short or Long Metal Shaft Version

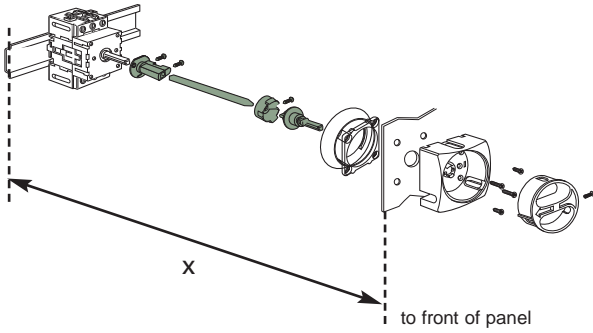

No Metal Shaft Version

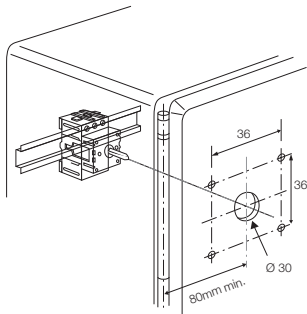
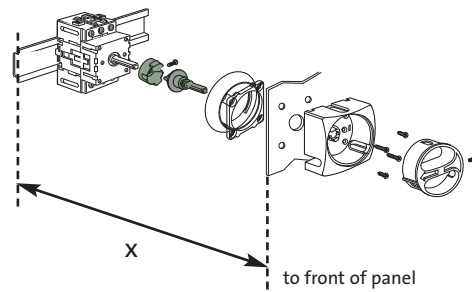

Minimum Distance to Hinge

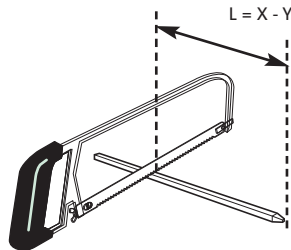

	X			Y
	without shaft	with short shaft	with long shaft	
25A / 32A	86 - 100 mm	125 - 250 mm	125 - 400 mm	92 mm
50A / 63A	96 - 110 mm	135 - 260 mm	135 - 410 mm	102 mm
80A / 100A	106 - 120 mm	145 - 270 mm	145 - 420 mm	112 mm