

Nominal data

Type 5938

Phase		1~
Nominal voltage	VAC	115
Frequency	Hz	60
Speed	min ⁻¹	2500
Power input	W	12.0
Min. ambient temperature	°C	-30
Max. ambient temperature	°C	55
Air flow	m ³ /h	162
Sound power level	B	4.9
Sound pressure level	dB(A)	40

ml = Max. load · me = Max. efficiency · fa = Running at free air · cs = Customer specs · cu = Customer unit
Subject to alterations

Technical features

Mass	0.570 kg
Dimensions	127 x 127 x 38 mm
Material of impeller	Fibreglass-reinforced plastic (PA)
Housing material	Die-cast aluminium
Direction of air flow	Exhaust over struts
Direction of rotation	Left, looking at rotor
Bearing	Ball bearings
Lifetime L10 at 40 °C	35000 h
Lifetime L10 at maximum temperature	20000 h
Connection line	2 flat connectors 2.8 x 0.5 mm. Housing with grounding lug for M4 x 6.
Motor protection	Protected from overload using impedance protection
Approval	VDE, CSA, UL, CE

5938

AC axial compact fan

Product drawing

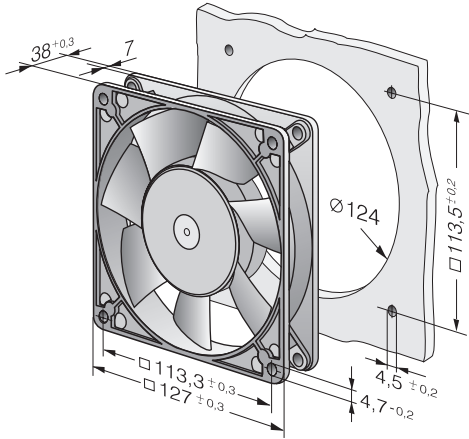

Charts: Air flow

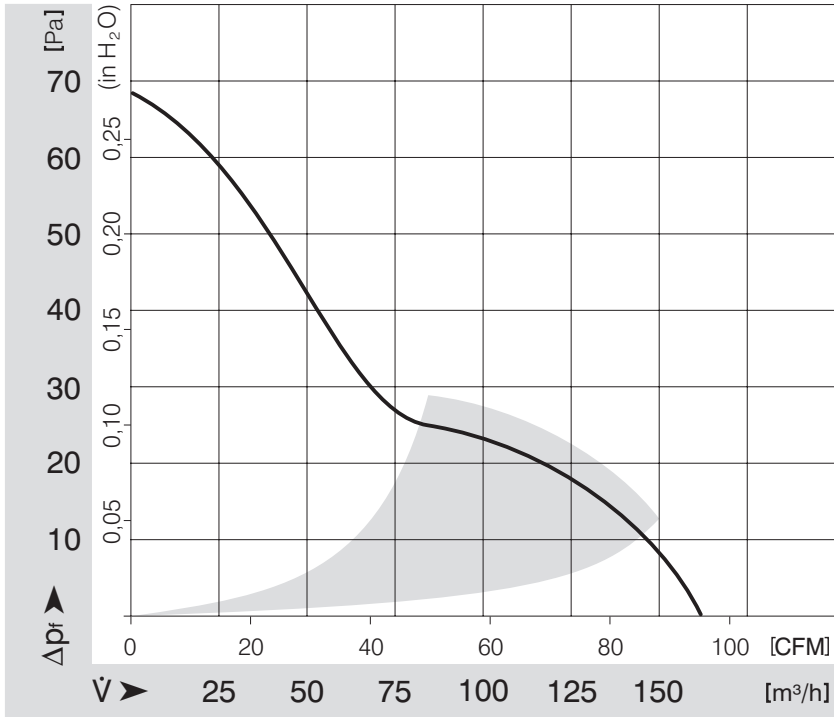

—