

**Product Information**

**Flow transmitter /-switch  
OMNI-HR2VE**



- Optimized for use with oil
- Analog output 4..20 mA or 0..10 V
- Two programmable switches
- Graphical LCD display, backlit, can be read in sunlight and in the dark
- Selectable units in the display
- Programmable parameters via rotatable, removable ring (programming protection)
- Electronics housing with non-scratch, chemically resistant glass
- Rotatable electronic housing for best reading position
- Designed for industrial use

**Characteristics**

Mechanical flow switch, for fluid media, with spring-supported piston and magnetic triggering of Hall sensors. Robust construction in brass or stainless steel.

The OMNI transducer located on the sensor has a backlit graphics LCD display which is very easy to read, both in the dark and in bright sunlight. The graphics display allows the presentation of measured values and parameters in a clearly understandable form. The measured values are displayed to 4 places, together with their physical unit, which may also be modified by the user. The electronics have an analog output (4..20 mA or 0..10 V) and two switching outputs, which can be used as limit switches for monitoring minimal or maximal, or as two-point controllers. The switching outputs are designed as push-pull drivers, and can therefore be used both as PNP and NPN outputs. Exceeding limit values is signaled by a red LED which is visible over a long distance, and by a clear text in the display.

The stainless steel housing has a hardened non-scratch mineral glass pane. It is operated by a programming ring fitted with a magnet, so there is no need to open the operating controls housing, and its leakproofness is permanently ensured.

By turning the ring to left or right, it is simple to modify the parameters (e.g. switching point, hysteresis...). To protect from unintended programming, it can be removed, turned through 180 ° and replaced, or completely removed, thus acting as a key.



**Technical data**

<b>Sensor</b>	analog Hall sensor	
<b>Nominal width</b>	DN 32 / 40 / 50	
<b>Process connection</b>	female thread G 1 1/4..G 2 (further process connections available on request)	
<b>Metering range</b>	10..160 l/min	for details see table "Ranges"
<b>Pressure loss</b>	~ 4..7 bar at Q <sub>max</sub>	
<b>Q<sub>max</sub></b>	up to 160 l/min	
<b>Measurement accuracy</b>	±5 % of full scale value at constant viscosity	
<b>Viscosity-stability</b>	±10 % of full scale value (20-330 mm <sup>2</sup> /s)	
<b>Pressure resistance</b>	PS 200 bar	
<b>Medium temperature</b>	-20..+85 °C, optionally -20..+100 °C	
<b>Ambient temperature</b>	-20..+70 °C	
<b>Media</b>	oil	
<b>Wiring</b>	see section "Wiring"	
<b>Materials medium-contact</b>	Brass construction: CW614N nickelled, CW614N, 1.4305, 1.4310, hard ferrite,	Stainless steel construction: 1.4571, 1.4310, hard ferrite
<b>Materials, non-medium-contact</b>	Electronic adapter Electronics housing Glass  Magnet Ring	CW614N nickelled Stainless steel 1.4305 Mineral glass, hardened Samarium-Cobalt POM
<b>Supply voltage</b>	18..30 V DC	
<b>Power consumption</b>	<1 W	
<b>Analog output</b>	4..20 mA / max. load 500 Ω or 0..10 V / min. load 1 kΩ	
<b>Switching output</b>	Transistor output "Push-Pull" (resistant to short circuits and polarity reversal) I <sub>out</sub> = 100 mA max.	
<b>Hysteresis</b>	adjustable, position of the hysteresis depends on minimum or maximum	
<b>Display</b>	extendable graphic LCD display Temperature range -20..+70 °C, 32 x 16 pixels, background illumination, displays value and unit, flashing LED signal lamp with simultaneous message on the display	
<b>Electrical connection</b>	for round plug connector M12x1, 5-pole	
<b>Ingress protection</b>	IP 67 (IP 68 when oil-filled)	
<b>Weight</b>	see table "Dimensions and weights"	
<b>Conformity</b>	CE	
<b>Installation location</b>	Standard: horizontal inwards flow; other installation positions are possible; the installation position affects the display, metering and switching range.	

**Product Information**

**Signal output curves**

Value x = begin of the specified range  
 = not specified range

Current output

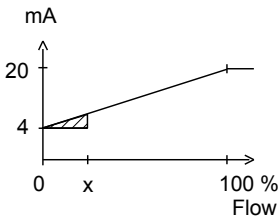

Voltage output

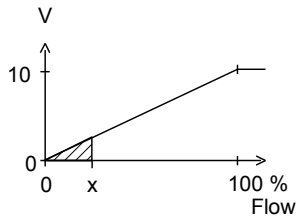

Other characteristics on request.

**Ranges**

Details in the table correspond to metering ranges with horizontal inwards flow and increasing flow rate.

**Standard type OMNI-HR2VE**

Metering range l/min oil 20-330 mm <sup>2</sup> /s	Q <sub>max.</sub> Recommended l/min	Pressure loss bar at Q <sub>max.</sub> oil
10 - 80	100	4
20 - 120	120	5
30 - 140	140	5
50 - 160	160	7

Special ranges are available.

**Reference Data:**

Pressure drop (Pa) to Flow (Q)

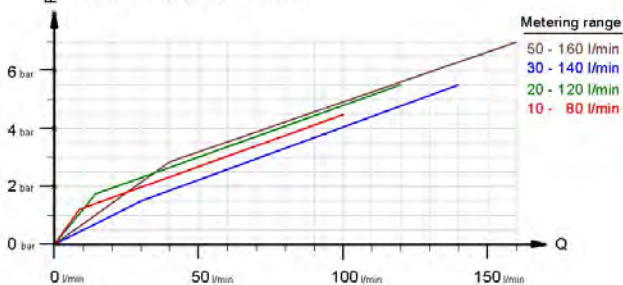

Metering spaces of the flow switch HR2VK1

**Wiring**

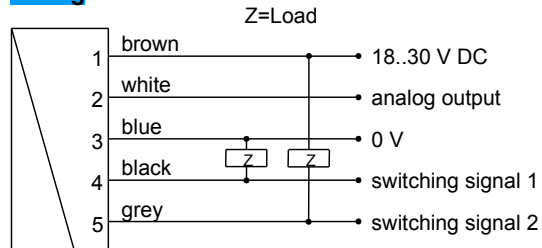

Connection example: PNP NPN

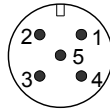

Before the electrical installation, it must be ensured that the supply voltage corresponds to the data sheet.

It is recommended to use shielded wiring.

The Push-Pull output) can as desired be switched as a PNP or an NPN output.

**Dimensions and weights**

..including OMNI-electronics

DN	G	Types	L	ØD	SW	Ød	X	Weight kg
32	G 1 <sup>1</sup> / <sub>4</sub>	HR2VE-032GM	130	65	60	51	23	2.8
40	G 1 <sup>1</sup> / <sub>2</sub>	HR2VE-040GM	170	65	60	56	24	3.3
50	G 2	HR2VE-050GM	185	80	75	70	26	5.5

**High temperature**

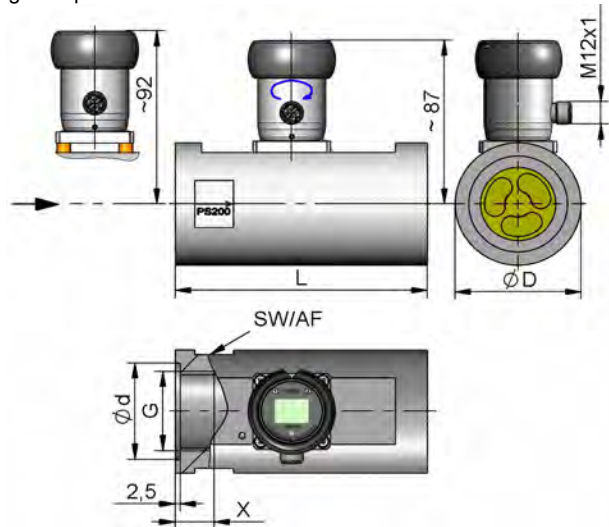

**Gooseneck option**



A gooseneck (optional) between the electronics head and the primary sensor provides freedom in the orientation of the sensor. This option simultaneously provides thermal decoupling between the two units

**Product Information**

**OMNI-HR2VE**

**Handling and operation**

**Note**

- Include straight calming section of 5 x DN in inlet and outlet
- If the media are dirty, install a filter (use magnetic filter for ferritic components)
- Under unfavorable pressure conditions, e.g. with a free outlet, there is a risk of cavitation.

The electronics housing is permanently connected to the primary sensor. There is no electrical connection between the electronics and the piston device. After installation, the electronic head can be turned to align the cable outlet. It should be ensured that the piston device and the OMNI electronics are appropriately matched to each other.

**Programming**

The annular gap of the programming ring can be turned to positions 1 and 2. The following actions are possible:



**Set to 1 = continue (STEP)  
 Set to 2 = modify (PROG)**

**Neutral position between 1 and 2**

The ring can be removed to act as a key, or turned through 180 ° and replaced to create a programming protector. Operation is by dialog with the display messages, which makes its use very simple. Starting from the normal display (present value and unit), if 1 (STEP) is repeatedly selected, then the display shows the following information in this order:

**Display of the parameters, using position 1**

- Switching value S1 (switching point 1 in the selected unit)
  - Switching characteristic of S1  
 MIN = Monitoring of minimum value  
 MAX = Monitoring of maximum value
  - Hysteresis 1 (hysteresis value of S1 in the set unit)
  - Switching value S2
  - Switching characteristic of S2
  - Hysteresis 2
  - Code
- After entering the **code 111**, further parameters can be defined:
- Filter (settling time of the display and output)
  - Physical unit (Units)
  - Output: 0..20 mA or 4..20 mA
  - 0/4 mA (measured value corresponding to 0/4 mA)
  - 20 mA (measured value corresponding to 20 mA)

For models with a voltage output, replace 20 mA accordingly with 10 V.

**Edit, using position 2**

- If the currently visible parameter is to be modified:
- Turn the annular gap to position 2, so that a flashing cursor appears which displays the position which can be modified.
  - By repeatedly turning to position 2, values are increased; by turning to position 1, the cursor moves to the next digit.
  - Leave the parameter by turning to position 1 (until the cursor leaves the row); this accepts the modification.
  - If there is no action within 30 seconds, the device returns to the

normal display range without accepting the modification.

The limit switches S1 and S2 can be used to monitor minimal or maximal.

With a minimum-switch, falling below the limit value causes a switchover to the alarm state. Return to the normal state occurs when the limit value plus the set hysteresis is once more exceeded.

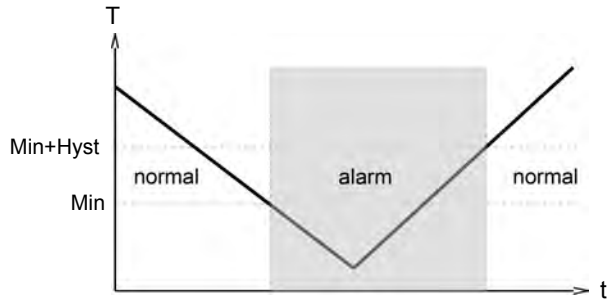

With a maximum-switch, exceeding the limit value causes a switchover to the alarm state. Return to the normal state occurs when the measured value once more falls below the limit value minus the set hysteresis.

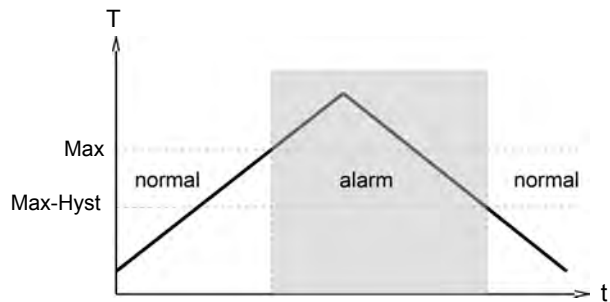

The change to the alarm state is indicated by the integrated red LED and a clear text in the display. While in the normal state, the switching outputs are at the level of the supply voltage; in the alarm state they are at 0 V, so that a wire break would also display as an alarm state at the signal receiver.

**Overload display**

Overload of a switching output is detected and indicated on the display ("Check S1 / S2"), and the switching output is switched off.

**Simulation mode**

To simplify commissioning, the sensor provides a simulation mode for the analog output. It is possible to create a programmable value in the range 0..26.0 mA at the output (without modifying the process variable). This allows the wiring run between the sensor and the downstream electronics to be tested during commissioning. This mode is accessed by means of code **311**.

**Factory settings**

After modifying the configuration parameters, it is possible to reset them to the factory settings at any time using **Code 989**.

## Product Information

OMNI-HR2VE

### Ordering code

The basic device is ordered e.g. HR2VE-032GM100 with electronics e.g. OMNI-HR2VE-ISO

HR2VE -  1.  2.  3.  4.

OMNI - HR2VE -  5.  6.  7.

○=Option

<b>1. Nominal width</b>	
032	DN 32 - G 1 <sup>1</sup> / <sub>4</sub>
040	DN 40 - G 1 <sup>1</sup> / <sub>2</sub>
050	DN 50 - G 2
<b>2. Process connection</b>	
G	female thread
<b>3. Connection material</b>	
M	brass
K	stainless steel
<b>4. HR2VE - Metering range H<sub>2</sub>O for horizontal inwards flow</b>	
080	10.. 80 l/min
120	20..120 l/min
140	30..140 l/min
160	50..160 l/min

<b>5. Analog output</b>	
I	current output 0/4..20 mA
U	○ voltage output 0/2..10 V
<b>6. Electrical connection</b>	
S	for round plug connector M12x1, 5-pole
<b>7. Option 1</b>	
D	high temperature up to 120°C
H	model with gooseneck
O	○ tropical model - oil-filled version for heavy duty or external use

### Options

- Special quantities

### Ordering information

- Specify direction of flow, medium, and metering range.

### Accessories

- Cable/round plug connector (KB...) see additional information "Accessories"
- Device configurator ECI-1