

MODEL PAXLHV - PAX LITE AC VOLTAGE MONITOR



- 3-DIGIT, 0.56" (14.2 mm) HIGH LED DISPLAY
- AUTO ZEROING CIRCUIT
- NEMA 4X/IP65 SEALED FRONT BEZEL
- OPTIONAL CUSTOM UNITS OVERLAY W/BACKLIGHT
- UP TO 600 VAC MAX



GENERAL DESCRIPTION

The Model PAXLHV is designed for AC voltage monitoring. The half-wave rectified input signal is calibrated to indicate the RMS value of a pure sinusoidal wave-form. The front bezel meets NEMA 4X/IP65 requirements when properly installed.

SAFETY SUMMARY

All safety related regulations, local codes and instructions that appear in the literature or on equipment must be observed to ensure personal safety and to prevent damage to either the instrument or equipment connected to it. If equipment is used in a manner not specified by the manufacturer, the protection provided by the equipment may be impaired.



CAUTION: Read complete instructions prior to installation and operation of the unit.



CAUTION: Risk of electric shock.

DEFINITION OF TERMS

INSTALLATION CATEGORY (overvoltage category) I:

Signal level, special equipment or parts of equipment, telecommunication, electronic, etc. with smaller transient overvoltages than Installation Category (overvoltage category) II.

INSTALLATION CATEGORY (overvoltage category) II:

Local level, appliances, portable equipment, etc. with smaller transient overvoltages than Installation Category (overvoltage category) III.

DIMENSIONS In inches (mm)

Note: Recommended minimum clearance (behind the panel) for mounting clip installation is 2.1" (53.4) H x 5.0" (127) W.

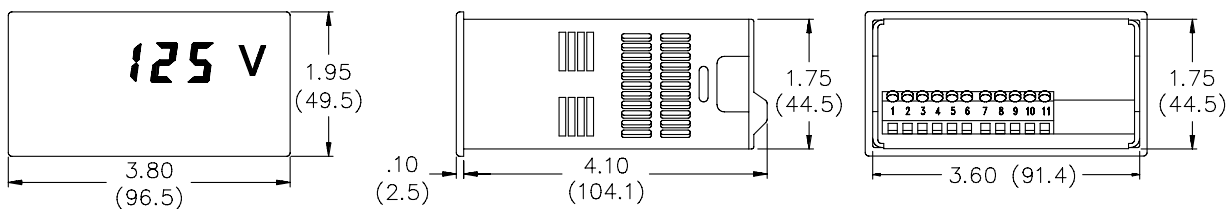
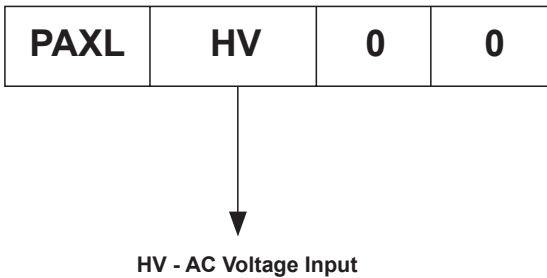

TABLE OF CONTENTS

Ordering Information	2	Installing the Meter	4
General Meter Specifications	3	Setting the Switches	4
Accessories	3	Wiring the Meter	5

ORDERING INFORMATION

Meter Part Numbers



Accessories Part Number

TYPE	MODEL NO.	DESCRIPTION	PART NUMBERS
Accessories	PAXLBK	Units Label Kit Accessory	PAXLBK30

GENERAL METER SPECIFICATIONS

1. **DISPLAY:** 3-digit, 0.56" (14.2 mm) high character, 7-segment Red LED
2. **POWER:** 115 or 230 VAC, switch selectable. Allowable power line variation $\pm 10\%$, 50/60 Hz, 6 VA. Installation Category II, Pollution Degree 2.
Isolation: 2300 Vrms for 1 min. to input
Working Voltage: 300 V max., CAT II
3. **ACCURACY:** At 23°C, 85% R.H.; $\pm(0.1\%$ of Reading + 2 digits)
4. **INPUT IMPEDANCE:** 1 M Ω
5. **INPUT RANGE:** 0 to 600 VAC max. @ 45 to 500 Hz. Installation Category I
6. **RESOLUTION:** 1 VAC
7. **ENVIRONMENTAL CONDITIONS:**
Operating Temperature Range: 0° to 60°C
Storage Temperature Range: -40° to 80°C
Operating and Storage Humidity: 85% max. relative humidity (non-condensing)
Temperature Coefficient: ± 150 PPM/°C
Altitude: Up to 2000 meters
8. **READING RATE:** 400 msec., nominal
9. **RESPONSE TIME:** 1 sec. nominal for a step change input.
10. **CERTIFICATIONS AND COMPLIANCES:**

SAFETY

- UL Recognized Component, File #E179259, UL3101-1, CSA C22.2 No. 1010-1
Recognized to U.S. and Canadian requirements under the Component Recognition Program of Underwriters Laboratories Inc.
- UL Listed, File #E137808, UL508, CSA C22.2 No. 14-M95
LISTED by Und. Lab. Inc. to U.S. and Canadian safety standards
Type 4X Enclosure rating (Face only), UL50
- IECEE CB Scheme Test Certificate #UL/7470/UL
CB Scheme Test Report #03ME09282-08292003
Issued by Underwriters Laboratories, Inc.
- IEC 1010-1, EN 61010-1: Safety requirements for electrical equipment for measurement, control, and laboratory use, Part 1.
IP65 Enclosure rating (Face only), IEC 529

ELECTROMAGNETIC COMPATIBILITY:

Emissions and Immunity to EN 61326: Electrical Equipment for Measurement, Control and Laboratory use.

Immunity to Industrial Locations:

Electrostatic discharge	EN 61000-4-2	Criterion A 4 kV contact discharge 8 kV air discharge
Electromagnetic RF fields	EN 61000-4-3	Criterion B 10 V/m
Fast transients (burst)	EN 61000-4-4	Criterion A 2 kV power 2 kV signal
Surge	EN 61000-4-5	Criterion A 1 kV L-L, 2 kV L&N-E power
RF conducted interference	EN 61000-4-6	Criterion A 3 V/rms
Voltage dip/interruptions	EN 61000-4-11	Criterion A 0.5 cycle; 40 % variation

Emissions:

Emissions	EN 55011	Class B
-----------	----------	---------

Notes:

1. *Criterion A: Normal operation within specified limits.*
 2. *Criterion B: Temporary loss of performance from which the unit self-recovers.*
11. **CONNECTIONS:** High compression cage-clamp terminal block
Wire Strip Length: 0.3" (7.5 mm)
Wire Gauge: 30-14 AWG copper wire
Torque: 4.5 inch-lbs (0.51 N-m) max.
 12. **CONSTRUCTION:** This unit is rated for NEMA 4X/IP65 use. Installation Category II, Pollution Degree 2. One piece bezel/case. Flame resistant. Panel Gasket and mounting clip included.
 13. **WEIGHT:** 0.65 lbs. (0.24 Kg)

ACCESSORIES

UNITS LABEL KIT (PAXLBK)

Each meter has a units indicator with backlighting that can be customized using the Units Label Kit. The backlight is controlled by a DIP switch.

1.0 INSTALLING THE METER

Installation

The PAX meets NEMA 4X/IP65 requirements when properly installed. The unit is intended to be mounted into an enclosed panel. Prepare the panel cutout to the dimensions shown. Remove the panel latch from the unit. Slide the panel gasket over the rear of the unit to the back of the bezel. The unit should be installed fully assembled. Insert the unit into the panel cutout.

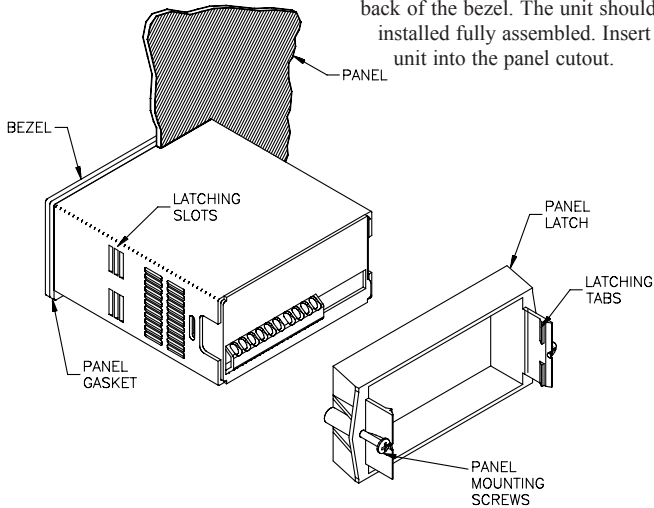

While holding the unit in place, push the panel latch over the rear of the unit so that the tabs of the panel latch engage in the slots on the case. The panel latch should be engaged in the farthest forward slot possible. To achieve a proper seal, tighten the latch screws evenly until the unit is snug in the panel (Torque to approximately 7 in-lbs [79N-cm]). Do not over-tighten the screws.

Installation Environment

The unit should be installed in a location that does not exceed the maximum operating temperature and provides good air circulation. Placing the unit near devices that generate excessive heat should be avoided.

The bezel should be cleaned only with a soft cloth and neutral soap product. Do NOT use solvents. Continuous exposure to direct sunlight may accelerate the aging process of the bezel.

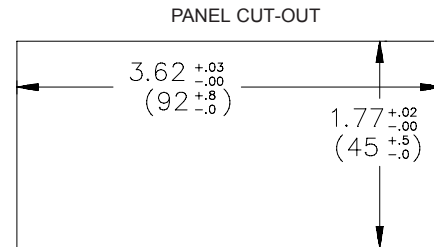

2.0 SETTING THE SWITCHES

The meter has a switch, which must be checked and/or changed prior to applying power. To access the switch, remove the meter base from the case by firmly squeezing and pulling back on the side rear finger tabs. This should lower the latch below the case slot (which is located just in front of the finger tabs). It is recommended to release the latch on one side, then start the other side latch.

Power Selection Switch



Caution: Insure the AC power selection switch is set for the proper voltage before powering-up the meter. The meter is shipped from the factory in the 230 VAC position.

Set-Up DIP Switches

A DIP switch is located inside the meter. It is used for the selection of decimal points and backlight annunciator. Selecting the "ON" position enables the function.

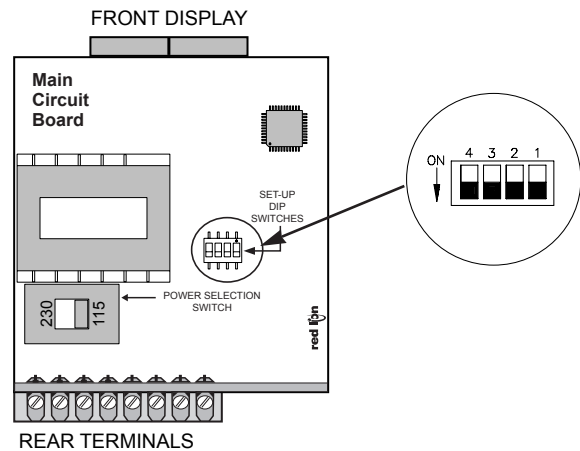

SWITCH	FUNCTION
1	Decimal Point 1 (000.0)
2	Decimal Point 2 (00.00)
3	Decimal Point 3 (0.000)
4	Backlight Annunciator for Units Label

3.0 WIRING THE METER

WIRING OVERVIEW

All conductors should meet voltage and current ratings for each terminal. Also, cabling should conform to appropriate standards of good installation, local codes and regulations. It is recommended that power supplied to the unit be protected by a fuse or circuit breaker. As depicted in the drawing of the Model PAXLHV, all connections are made on the terminal block located at the rear of the unit.

BLOCK DIAGRAM

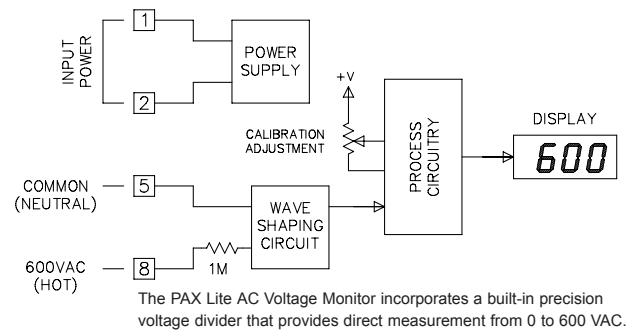

EMC INSTALLATION GUIDELINES

Although this meter is designed with a high degree of immunity to Electromagnetic Interference (EMI), proper installation and wiring methods must be followed to ensure compatibility in each application. The type of the electrical noise, source or coupling method into the meter may be different for various installations. Cable length, routing and shield termination are very important and can mean the difference between a successful or a troublesome installation. Listed below are some EMC guidelines for successful installation in an industrial environment.

1. The meter should be mounted in a metal enclosure, that is properly connected to protective earth.
2. Use shielded (screened) cables for all Signal and Control inputs. The shield (screen) pigtail connection should be made as short as possible. The connection point for the shield depends somewhat upon the application. Listed below are the recommended methods of connecting the shield, in order of their effectiveness.
 - a. Connect the shield only at the panel where the meter is mounted to earth ground (protective earth).
 - b. Connect the shield to earth ground at both ends of the cable, usually when the noise source frequency is above 1 MHz.
 - c. Connect the shield to common of the meter and leave the other end of the shield unconnected and insulated from earth ground.
3. Never run Signal or Control cables in the same conduit or raceway with AC power lines, conductors feeding motors, solenoids, SCR controls, and heaters, etc. The cables should be run in metal conduit that is properly grounded. This is especially useful in applications where cable runs are long and portable two-way radios are used in close proximity or if the installation is near a commercial radio transmitter.

4. Signal or Control cables within an enclosure should be routed as far as possible from contactors, control relays, transformers, and other noisy components.
5. In extremely high EMI environments, the use of external EMI suppression devices, such as ferrite suppression cores, is effective. Install them on Signal and Control cables as close to the unit as possible. Loop the cable through the core several times or use multiple cores on each cable for additional protection. Install line filters on the power input cable to the unit to suppress power line interference. Install them near the power entry point of the enclosure. The following EMI suppression devices (or equivalent) are recommended:

Ferrite Suppression Cores for signal and control cables:

Fair-Rite # 0443167251 (RLC #FCOR0000)

TDK # ZCAT3035-1330A

Steward #28B2029-0A0

Line Filters for input power cables:

Schaffner # FN610-1/07 (RLC #LFIL0000)

Schaffner # FN670-1.8/07

Corcom #1VB3

Corcom #1VR3

Note: Reference manufacturer's instructions when installing a line filter.

6. Long cable runs are more susceptible to EMI pickup than short cable runs. Therefore, keep cable runs as short as possible.

3.1 POWER WIRING

Primary AC power is connected to terminal 1 and 2 (*Marked AC Power, located on the left-hand side of the terminal block*). For best results, the AC power should be relatively "Clean" and within the specified $\pm 10\%$ variation limit. Drawing power from heavily loaded circuits or from circuits that also power loads that cycle on and off, should be avoided.

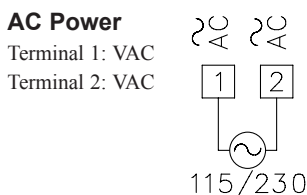

3.2 INPUT SIGNAL WIRING

Input connections are made on terminal 5 and 8. When powering the PAXLHV with the same voltage that is being measured, terminal 5 (COMM.) should be connected to neutral for the most stable reading on the display. If an unstable display results from measuring a voltage that is isolated from the supply voltage, reversing the supply voltage connections may correct this condition.

Voltage Input

Terminal 5: Common

Terminal 8: 600 VAC

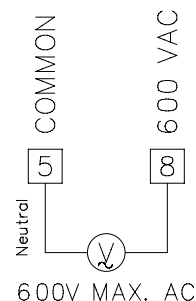

This page intentionally left blank

This page intentionally left blank

LIMITED WARRANTY

The Company warrants the products it manufactures against defects in materials and workmanship for a period limited to one year from the date of shipment, provided the products have been stored, handled, installed, and used under proper conditions. The Company's liability under this limited warranty shall extend only to the repair or replacement of a defective product, at The Company's option. The Company disclaims all liability for any affirmation, promise or representation with respect to the products.

The customer agrees to hold Red Lion Controls harmless from, defend, and indemnify RLC against damages, claims, and expenses arising out of subsequent sales of RLC products or products containing components manufactured by RLC and based upon personal injuries, deaths, property damage, lost profits, and other matters which Buyer, its employees, or sub-contractors are or may be to any extent liable, including without limitation penalties imposed by the Consumer Product Safety Act (P.L. 92-573) and liability imposed upon any person pursuant to the Magnuson-Moss Warranty Act (P.L. 93-637), as now in effect or as amended hereafter.

No warranties expressed or implied are created with respect to The Company's products except those expressly contained herein. The Customer acknowledges the disclaimers and limitations contained herein and relies on no other warranties or affirmations.

Red Lion Controls
20 Willow Springs Circle
York PA 17402
Tel +1 (717) 767-6511
Fax +1 (717) 764-0839

Red Lion Controls BV
Basicweg 11b
NL - 3821 BR Amersfoort
Tel +31 (0) 334 723 225
Fax +31 (0) 334 893 793

Red Lion Controls Asia
31, Kaki Bukit Road 3,
#06-04/05 TechLink
Singapore 417818
Tel +65 6744-6613
Fax +65 6743-3360