

ROCKER SWITCHES – R15

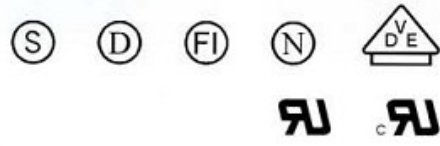
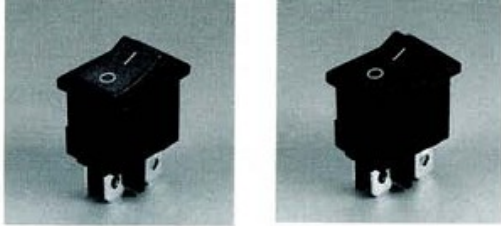

■ Features

- Power switch conforms to safety standards for electrical equipment.
- Compact with a good space factor.
- Snap-intype for easy mounting.
- The color can be changed to correspond to the set design.
- Two type of circuit configurations are available: single-pole single-throw and double-poles singlethrow.
- Lamps for 125V and for 250V respectively for illuminating type.

■ Characteristics

Item	Standard
Rating	10A 125V, 6A 250V AC
Insulation Resistance	100MΩ min (DC 500V)
Dielectric Strength	AC 1000V (50/60/Hz for 1 minute)
Contact Resistance	50 mΩ max
Electrically Life	10,000 cycles
Operating Temperature Range	-25°C ~ +85°C
Operating Force	650±150 gf

■ Order Guide

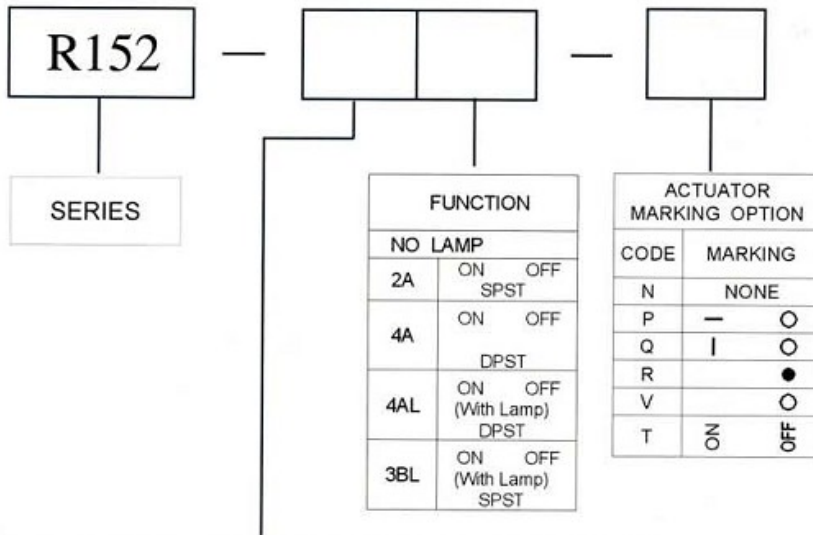

■ Panel hole size



PANEL THICKNESS	DIM. X	DIM. Y
0.75 ~ 1.25	19.2	13.0
1.25 ~ 2.0	19.4	13.0
2.0 ~ 3.0	19.6	13.0

TERMINAL TYPE					
CODE	TERMINAL	CODE	TERMINAL	CODE	TERMINAL
2		3		4	
Quick Connect	φ1.6 7.6 4.6	Soldering	4.5 2.8	PCB	5.0 5.3