

MagLev Green Motor Blower

4.8~5.7 CFM

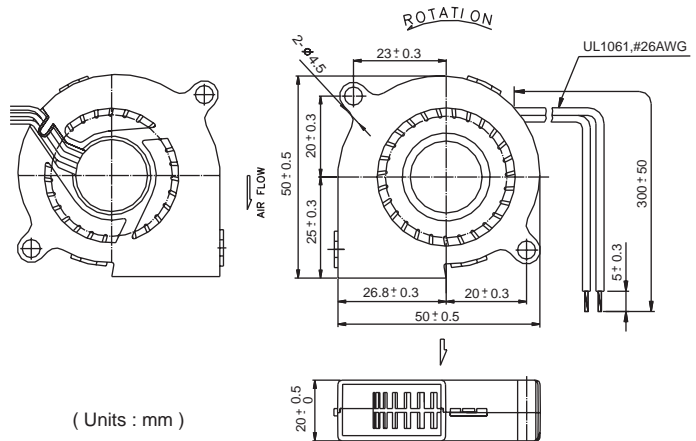

Model	P/N	Bearing ● VAPO ⊙ 2BALL	Rating Voltage (VDC)	Power Current (AMP)	Power Consumption (WATTS)	Speed (RPM)	Air Flow (CFM)	Static Pressure (Inch-H ₂ O)	Noise (dBA)	Weight (g)
GB1205PKV1-8AY	GN	●	12	0.12	1.4	5200	5.7	0.66	35	33
GB1205PKV2-8AY	GN	●	12	0.10	1.2	4800	5.2	0.56	33	33
GB1205PKV3-8AY	GN	●	12	0.08	1.0	4400	4.8	0.46	30	33

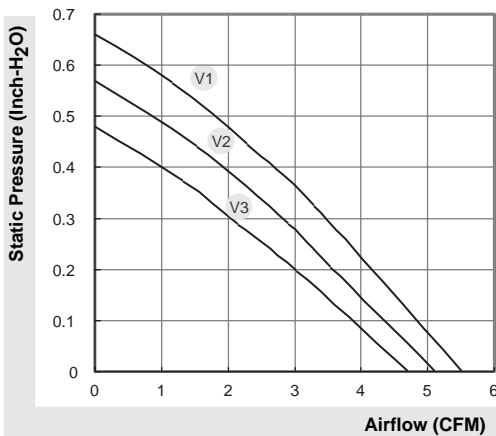

*All model could be customized on voltage or any other requirements to fit your need.

*Specifications subject to change without notice. Please Visit SUNON web site at <http://www.sunon.com> for update information.